

# PLANTERS





Designer: Alain Gilles (BE)

SPECIFICATIONS

MATERIAL	Cast stone
FIXING	Free-standing
WEIGHT	360 kg
FINISHES	Micro etched / Polished / Velvet
	Waterproof and anti-graffiti protection



GEOMETRY

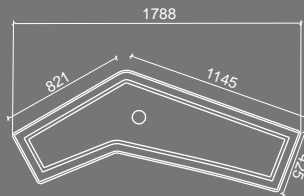

Top view

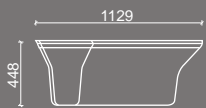

Side view

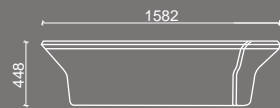

Front view

HANDLING

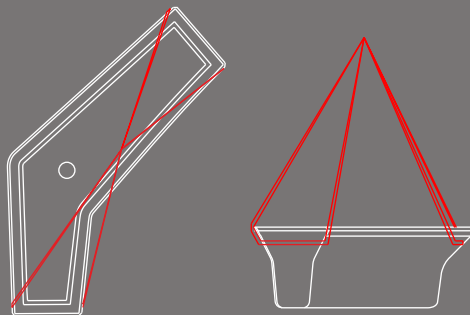

People in wheelchair can easily approach the planter and touch the plants. Perimeter is easily noticeable with white cane.



SPECIFICATIONS

MATERIAL	Cast stone
FIXING	Free-standing
WEIGHT	4.320 kg
FINISHES	Micro etched / Polished / Velvet Waterproof and anti-graffiti protection



GEOMETRY

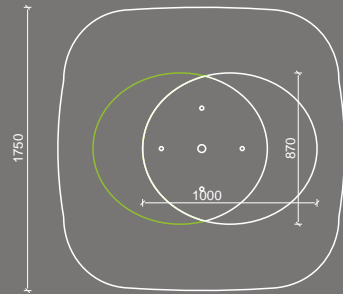
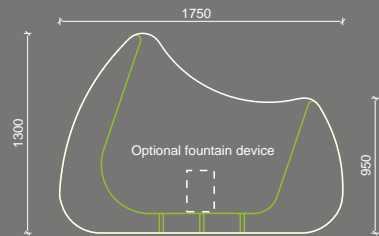

HANDLING

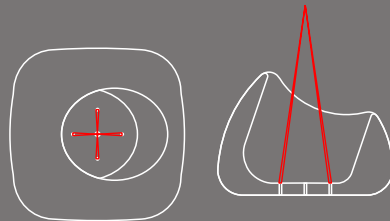

Perimeter is easily noticeable with white cane.  
Volume is easily understandable and friendly for people with cognitive disabilities.



Designer: Benjamin Pawlica (FR)

### SPECIFICATIONS

MATERIAL	Cast stone
FIXING	Free-standing
WEIGHT	295 kg
FINISHES	Micro etched Waterproof and anti-graffiti protection



### GEOMETRY

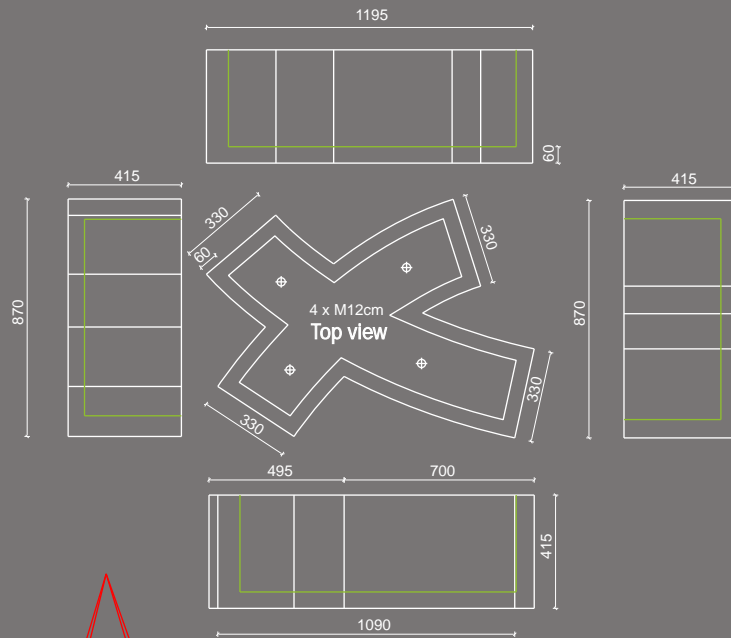

### HANDLING

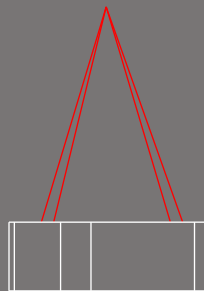

Perimeter is easily noticeable with white cane.



Designer: Roel Vandebek (BE)

SPECIFICATIONS

MATERIAL	Cast stone
FIXING	Incorporated
WEIGHT	600 kg
FINISHES	Micro etched / Polished / Velvet
	Waterproof and anti-graffiti protection

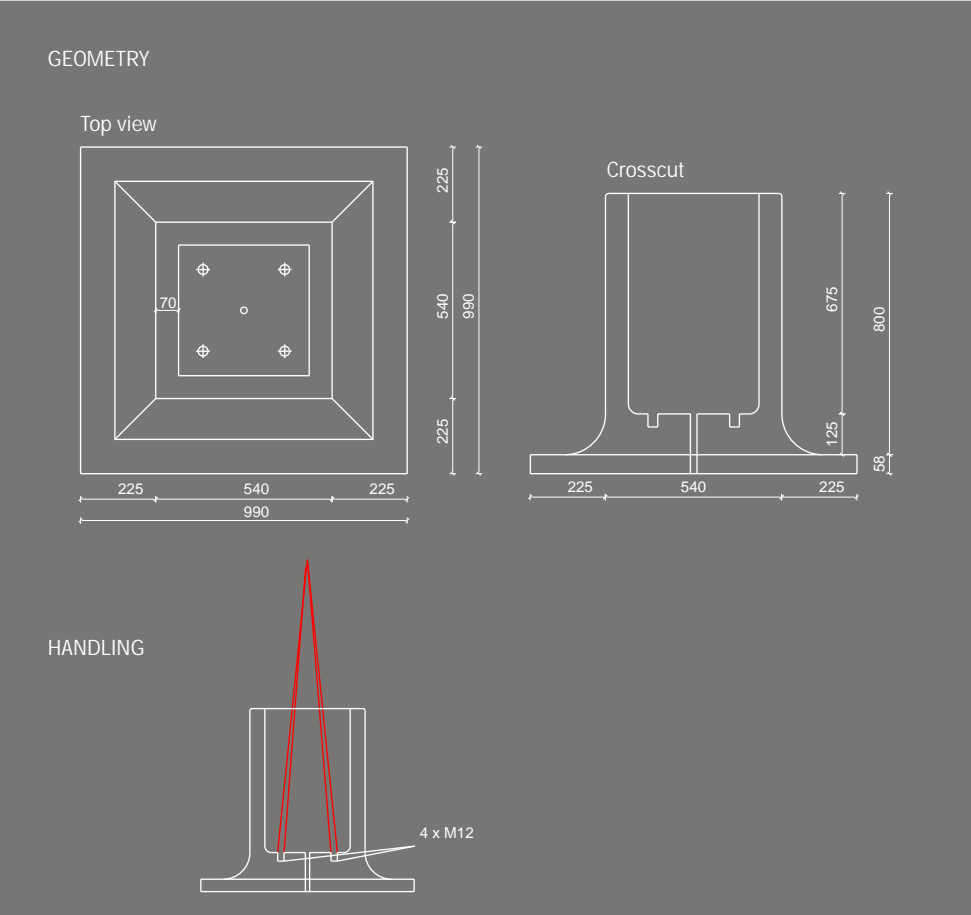

Planter Pop Up



Perimeter is easily noticeable with white cane.



SPECIFICATIONS

MATERIAL	Cast stone
FIXING	Free-standing
WEIGHT	370 kg
FINISHES	Micro etched Waterproof and anti-graffiti protection



GEOMETRY

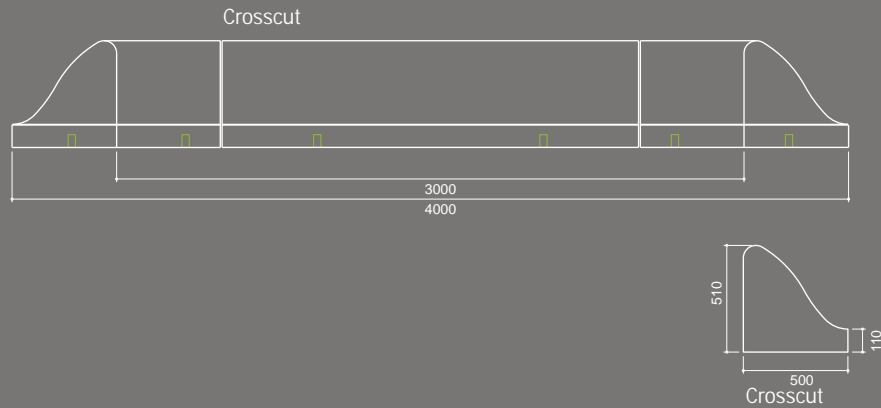

HANDLING

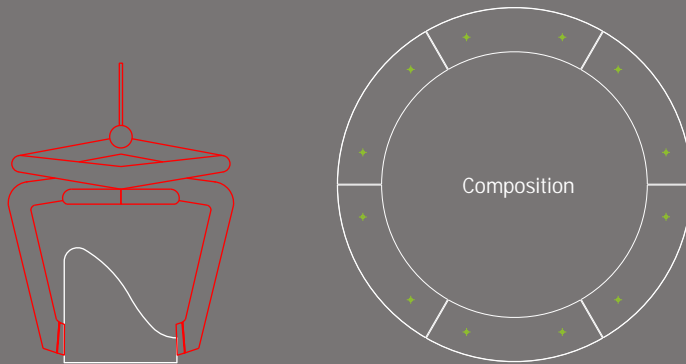

Perimeter is easily noticeable with white cane.



Designer: Arne Quinze (BE)

### SPECIFICATIONS

MATERIAL	Cast stone
FIXING	Free-standing
WEIGHT	370 kg
FINISHES	Micro etched Waterproof and anti-graffiti protection



### GEOMETRY

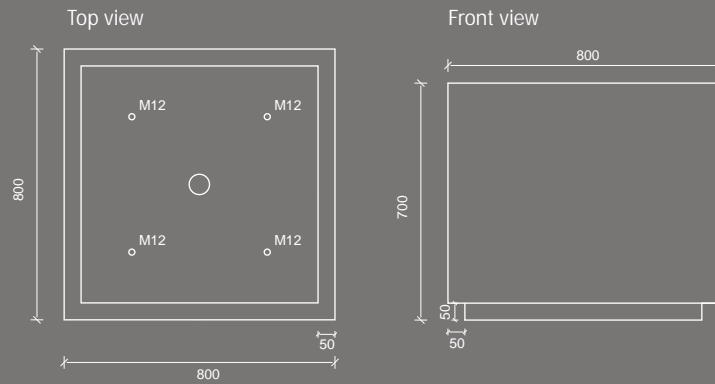

### HANDLING

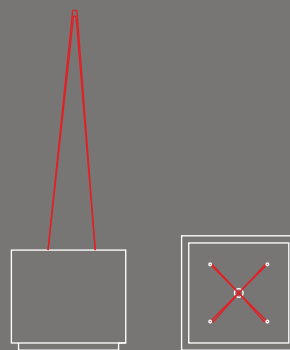

Perimeter is easily noticeable with white cane.



SPECIFICATIONS

MATERIAL	Cast stone
FIXING	Free-standing
WEIGHT	980 kg
FINISHES	Micro etched / Polished / Velvet Waterproof and anti-graffiti protection

GEOMETRY

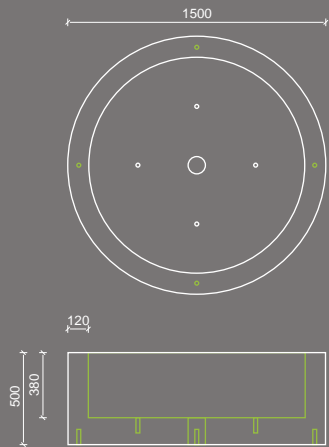

HANDLING

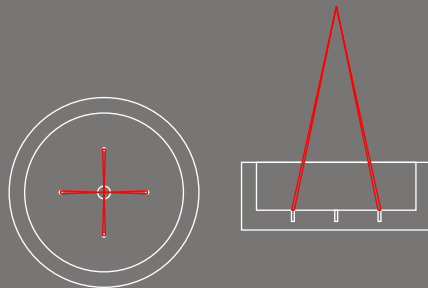

Perimeter is easily noticeable with white cane.





### SPECIFICATIONS

MATERIAL	Cast stone
FIXING	Free-standing
WEIGHT	see table
FINISHES	Micro etched Waterproof and anti-graffiti protection



### GEOMETRY

Top view

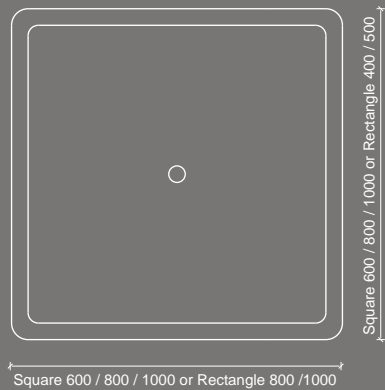

Front view

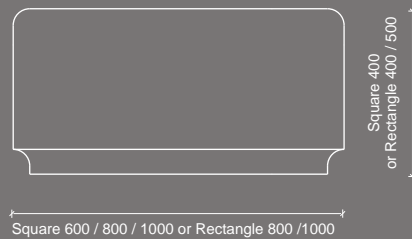

Side view

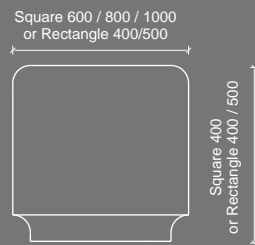

### HANDLING

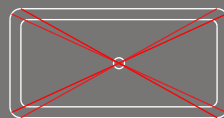
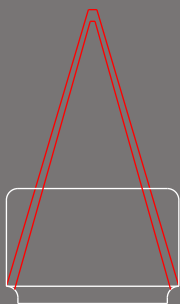

- Luna S - 60/60/40 cm - 230 kg
- Luna S - 80/80/40 cm - 270 kg
- Luna S - 100/100/40 cm - 370 kg
- Luna R - 80/40/40 cm - 180 kg
- Luna R - 100/50/50 cm - 230 kg

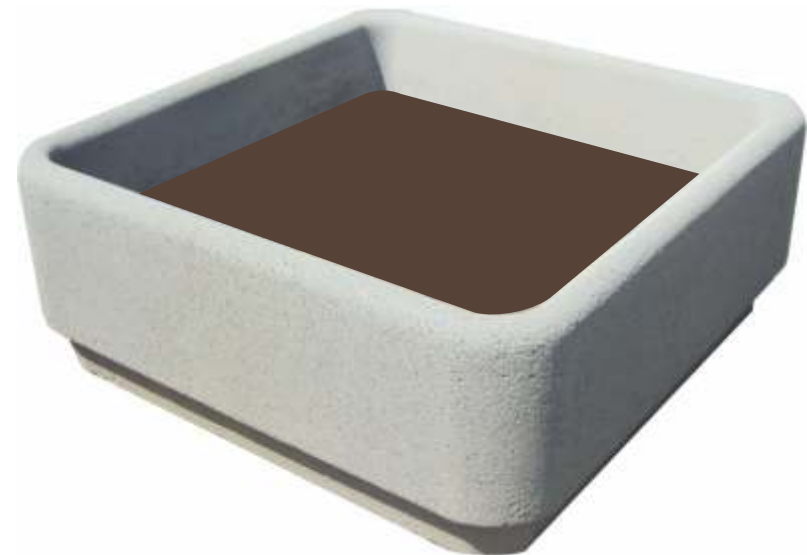

Perimeter is easily noticeable with white cane.



SPECIFICATIONS

MATERIAL Cast stone  
 FIXING Free-standing  
 WEIGHT Dia 80 cm - 220 kg / Dia 100 cm - 410 kg  
 100/80 cm - 290 kg  
 FINISHES Micro etched  
 Waterproof and anti-graffiti protection



GEOMETRY

Front view



Top view

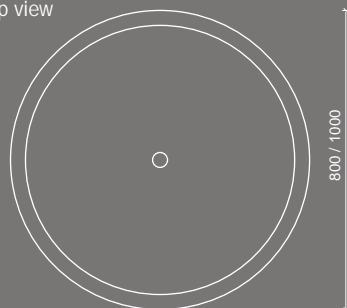

HANDLING

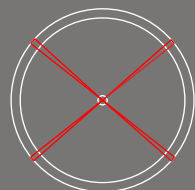
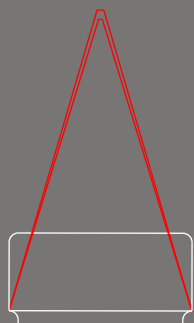

GEOMETRY

Top view

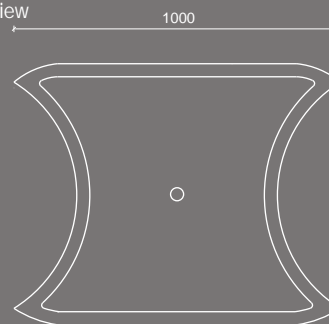

Front view

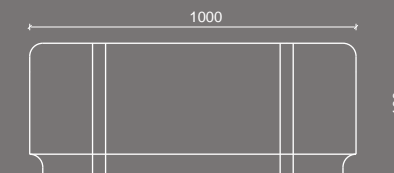

HANDLING

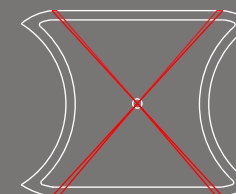
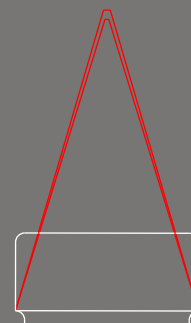

Perimeter is easily noticeable with white cane.



### SPECIFICATIONS

MATERIAL	Cast stone
FIXING	Free-standing
WEIGHT	see table
FINISHES	Fair faced / Micro etched / Polished / Velvet Waterproof and anti-graffiti protection



### GEOMETRY

Top view

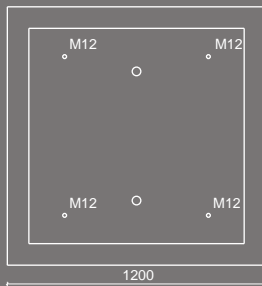

Crosscut



Top view

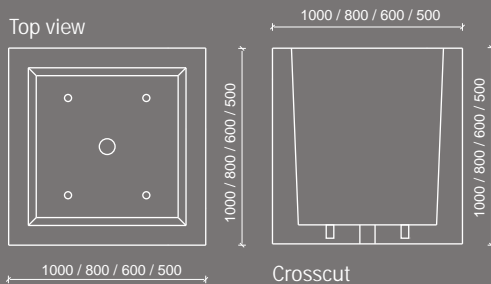

### HANDLING

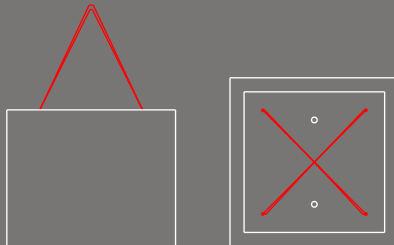

- Carree 120 - 120/120/50 cm - 10 cm thick - 950 kg
- Carree 100 - 100/100/100 cm - 10 cm thick - 1.017 kg
- Carree 80 - 80/80/80 cm - 8 cm thick - 522 kg
- Carree 60 - 60/60/60 cm - 6 cm thick - 230 kg
- Carree 50 - 50/50/50 cm - 5 cm thick - 110 kg



Perimeter is easily noticeable with white cane.



SPECIFICATIONS

MATERIAL	Cast stone
FIXING	Free-standing
WEIGHT	1.090 kg
FINISHES	Fair faced / Micro etched / Polished / Velvet Waterproof and anti-graffiti protection



GEOMETRY

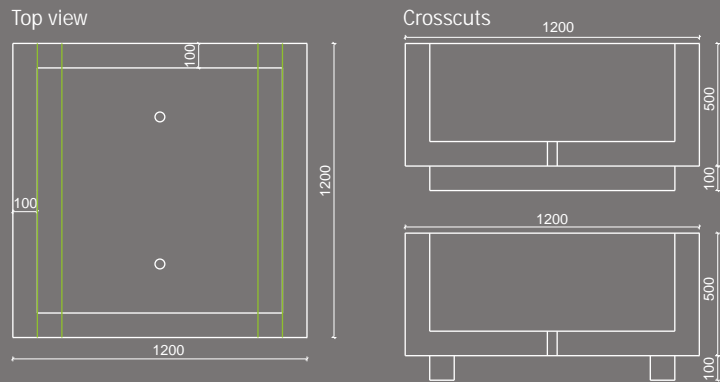

HANDLING

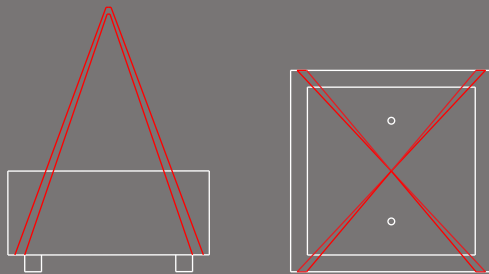

Perimeter is easily noticeable with white cane.



SPECIFICATIONS

MATERIAL	Cast stone
FIXING	Free-standing
WEIGHT	1.850 kg
FINISHES	Fair faced / Micro etched / Polished / Velvet
	Waterproof and anti-graffiti protection



GEOMETRY

Top view

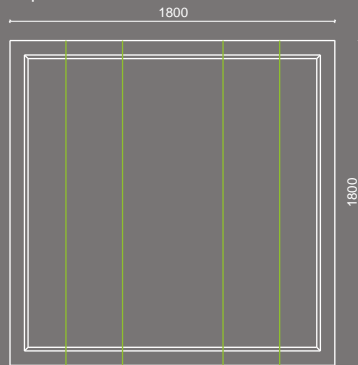

Front view

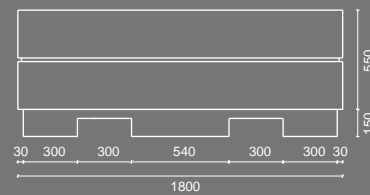

HANDLING

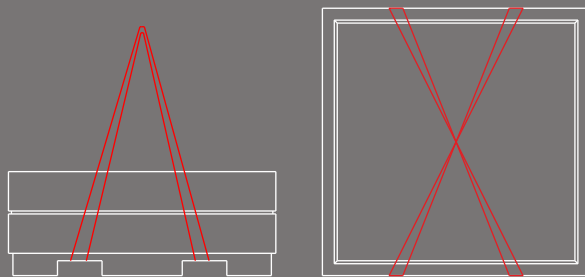

Perimeter is easily noticeable with white cane.



SPECIFICATIONS

MATERIAL Cast stone  
 FIXING Free-standing  
 WEIGHT see table

FINISHES Fair faced / Micro etched / Polished / Velvet  
 Waterproof and anti-graffiti protection

GEOMETRY

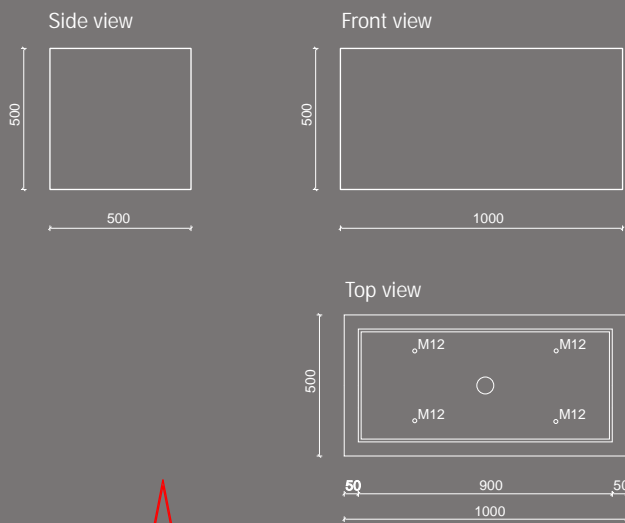

HANDLING

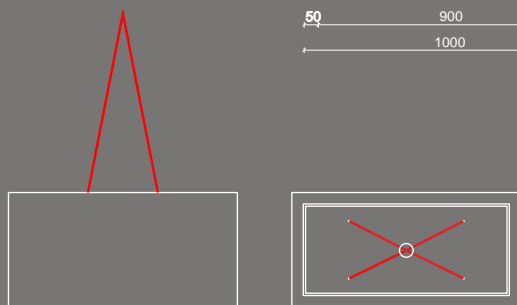

- Recto 2010 - 200/100/100 cm - 10 cm thick - 1.690 kg
- Recto 1510 - 150/100/100 cm - 10 cm thick - 1.353 kg
- Recto 1575 - 150/75/75 cm - 8 cm thick - 753 kg
- Recto 1050 - 100/50/50 cm - 5 cm thick - 220 kg



Perimeter is easily noticeable with white cane.