

Bollard Type 9.0



CHARACTERISATIONS

MATERIAL Cast stone
FIXING 1x M12 shelve - lenght 200 mm
WEIGHT 245 kg



Designer: Urba-Style (BE)

COLOUR

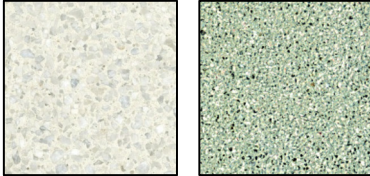

FINISHING Acid etched

Waterproof and anti-graffiti protection

HANDLING

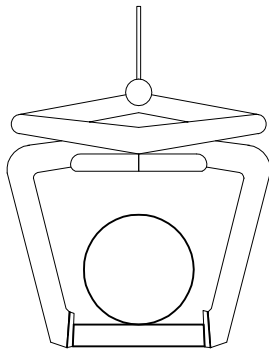

GEOMETRY

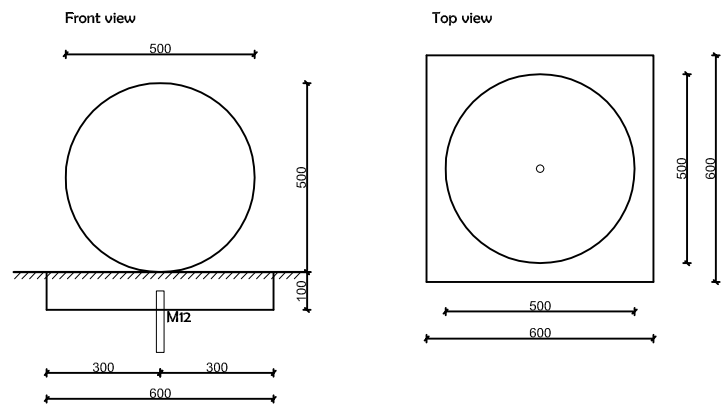

Detail

Scale 0 cm  40 cm

